

upb
since 1991

AILE[®]
GRUPA



OPERATION AND MAINTENANCE MANUAL

FOR WOOD ALUMINIUM
GLAZED STRUCTURES

AILE COto

01/2015

CONTENT

1.	Direction for use	3
2.	Improper use	4
3.	General information about maintenance	5
3.1.	Window protection during installation	5
3.2.	Technical inspection and maintenance of the wooden frame	5
3.3.	Joints between the frame and wall	7
3.4.	Seal	7
3.5.	Drainage	7
3.6.	Fittings	7
3.7.	Lubrication points	9
3.8.	Inspection and maintenance of the glass	9
3.9.	Inspection and maintenance report	13
4.	Ventilating your homes	13
5.	Advice and repair	13
6.	Complaint guidelines	14
6.1.	Delivery of the products	14
6.2.	Storage	14
6.3.	Correct installation	15
6.4.	Tolerances	15
6.5.	Complaint	16
7.	Warranty	16
8.	DVC – Dansk Vindues Certificering	17
Annex 1	Maintenance Report for Wood Aluminium Structures	19

1. DIRECTION FOR USE

To open an outwards opening window

The handle must be positioned precisely in one of the following positions:

- Locked position,
- Turning position,
- Winter ventilation position.

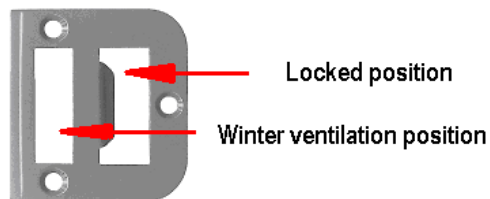

Please do not try to open the window when the handle is positioned in between these positions. The window sash must always be fully closed before changing the handle position.

If a window or balcony doors are equipped with a brake for handle fixing, before closing sashes make sure that brake is released!

Operational malfunction of the window components may result in injury!

Do not continue use the window once an operational malfunction has been identified!

Secure the window and instruct a specialist company to carry out the repairs!

Handle is locked.

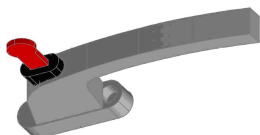

To open the window, turn the key in 90° clockwise.

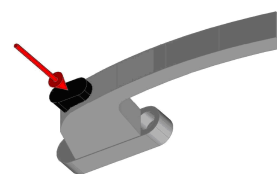
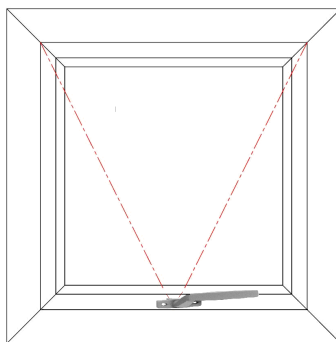
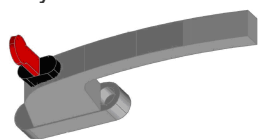

Press the button to unlock handle.

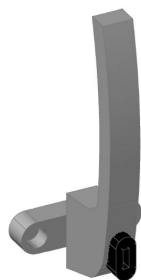

Keeping the button pushed, turn the handle in 90° clockwise. Move the casement outwards until it stops.

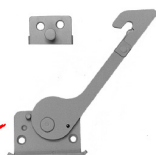
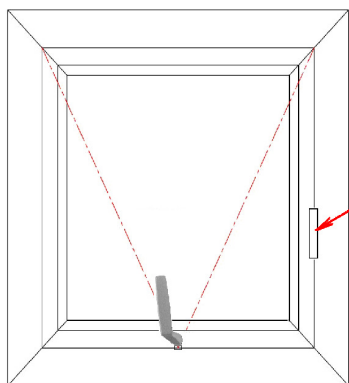
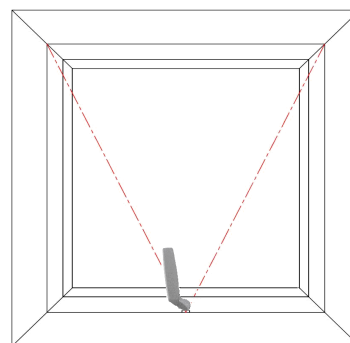

If a window is equipped with ironmongery, which secures child safety:

- open the window, the restrictor will automatically restrict the window;
- pull the sash 20mm, press the restrictor and open the window.



NB! From this moment child safety is inactivated!

1.3. To open fully reversible window

Open the window – the restrictor will automatically restrict the window.

Pull the sash 20mm - press the restrictor and open the window.

When the window is reversed for cleaning, restrictor will lock automatically. Disengage as mentioned in point above.

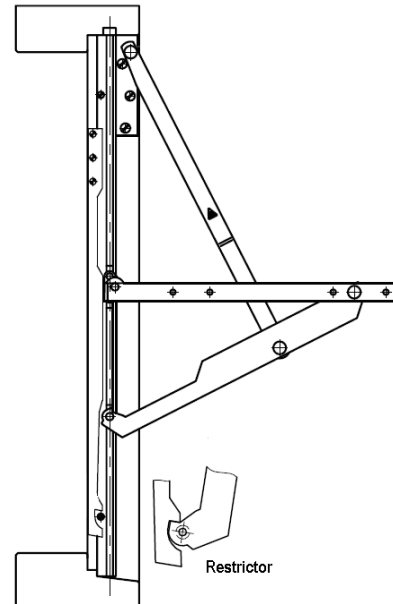

2. IMPROPER USE

The window casement may not be subjected to additional weight.

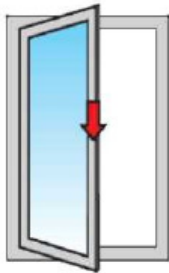

Do not knock or press sashes against the wall.

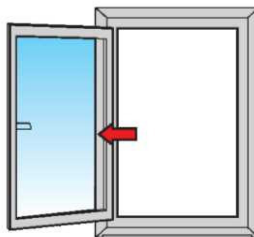

Do not place any objects between the sash and frame.

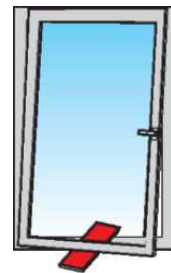

Danger! A sash, while being closed can lead to injury. When closing, please do not place hands or fingers between the sash and the frame!

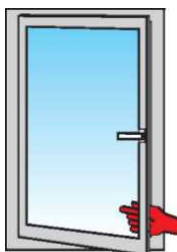

Where air movements are stronger, please do not leave the window open in a turning position!

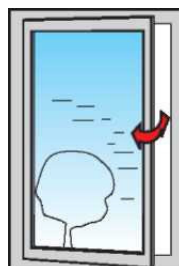

If required for personal safety, the sash shall be locked to prevent the turn mode of operation by means of a turn stop or a lockable operating handle, for example.



3. GENERAL INFORMATION ABOUT MAINTENANCE

Wood aluminium windows are easy to maintain. The outside aluminium parts are weather resistant and only need to be washed a couple of times each year to remove dirt from the surface. In order to avoid stains from soap and water etc. always clean the frame and sash at the same time as the glazing. In addition, the aluminium sash can be treated with a non abrasive car wax which will give an *as new* finish and will help to repel any dirt.

Moving parts such as mountings should be lubricated when required. However, they must be oiled at least twice a year, see 3.7. If guides, seals etc. are kept free of dirt and dust, the window will be fully functional for many years into the future.

3.1. Windows protection during installation

Protect wood windows against dirt and damage during installation and the subsequent construction and recovery works. Before you use an adhesive tape, make sure that it is suitable for wood aluminium windows (some tapes may damage the coating). Regardless of the type, adhesive tape stuck to the window for too long may damage the surface.

The initial cleaning after construction is completed, should always be performed with an ample quantity of water. The easiest way to perform normal window cleaning is with a cloth or sponge and squeegee. Wash with lukewarm water containing a small amount of detergent and scrape off with a squeegee. The corners and lower surfaces should be dried with a shammy or a dry cloth.

If conditions during normal window cleaning do not allow water to be spilled or if the glass surfaces are very small, the glass can be cleaned with an ordinary window cleaner, while the frame and sash should be wiped with a damp cloth using water containing detergent. Hard brushing, scrubbing or the use of steel wool may result in scratches and should therefore be avoided.

Clear all fitting parts of any splashed lime, cement or grout particles in order to prevent malfunctions as a result of the fittings becoming obstructed.

Seals must not be cleaned with cleaning agents like paraffin, thinner etc. Any mildew or mould on the surface of the glazing gasket should be removed with diluted bleach.

After installation check all the opening mechanisms. Please pay special attention to water drainage holes and, if necessary, clean the dirt from them. Provide adequate air circulation so that the resulting moisture could evaporate quickly (applies to buildings in construction). On completion of the construction works inside and outside the building, remove protective film from the windows and clean them thoroughly with water.

3.2. Technical inspection and maintenance of the wooden frame

Regular visual inspection of coatings ensures quick detection of possible damage. Maintenance carried out in a timely manner prevents the widening damage and, as a result, saves time and helps avoid unnecessary expenses.

As the aluminium parts cover the wooden frame on the window and protect it against sun and rain, actual maintenance will often be performed when re-painting is wanted. However, please check for any wear on the treated surface, especially on the part of the frame that faces out.

Cleaning

Twice a year (preferably before summer and winter), the surface of wood windows should be thoroughly cleaned of dust, insects' remains, and other surface debris by using mild detergent and water. This should be done not only for aesthetic reasons - this type of debris may lead to the appearance of green algae and fungi, which damage the varnish coating.



Do not use high pressure cleaner for cleaning glazed structures!

Products recommended to clean and care of wood window frames (can be bought at the window manufacturer):

- Cleaning product TEKNOS GORI 690 Clean - effectively removes dirt, grease and other contaminants from wooden surfaces;
- Care product TEKNOS GORI 690 Care - gives a new shine and protection to surfaces damaged by sunshine, rain and frost.

To prevent damage, observe the instructions given on the cleaning agent. The following items must NOT be used for cleaning:



- Tools with sharp edges, e.g. knives, metal scrapers, steel wool, the scouring side of household sponges etc. will damage surfaces.
- Aggressive cleaning fluids or solvents, e.g. cellulose thinner, nail polish remover, etc., will also cause irreversible damage to surfaces.

Coating renovation

Coating should be renovated when it becomes thinner or when micro-cracks are noticed.

Use the same products to recoat the window frames as those previously used by the manufacturer.



Always read all of the instructions on the product packet thoroughly before commencing any work!

Application of wood preservative base coat or top coat cannot be done in temperatures below 8°C and relative humidity exceeding 80%. We do not recommend application of coatings in bright sunshine.

Before commencing renovation:



Protect hinge mechanisms and handles from covering with coating;
All areas to be recoated should be thoroughly cleaned with a mild detergent and rinsed with clean water.

Renovation process depending on the degree of surface damage:

- **The coating system is intact and requires a cosmetic coat only**

Using a long haired synthetic brush designed for use with acrylic paints, apply two layers of topcoat in the appropriate color and gloss level. Allow to dry for four hours before applying the second coat.

- **Minor flaking affecting topcoat surface without wood damage**

Abrade the damaged areas with a fine grade abrasive paper making sure that you do not remove the basecoat. Thoroughly clean to remove dust, wash and let the surface dry.

Using a long haired synthetic brush designed for use with acrylic paints, apply two layers of topcoat in the appropriate color and gloss level. Allow to dry for four hours before applying the second coat.

- **Extensive surface damage**

Abrade the entire window frame using a fine grade abrasive paper making sure you do not remove the basecoat. Thoroughly clean to remove dust, wash and let the surface dry.

Using a long haired synthetic brush designed for use with acrylic paints, apply two layers of topcoat in the appropriate color and gloss level. Allow to dry for four hours before applying the second coat.

- **The coating is extremely damaged, e.g. the coating is cut or there is a hole in it:**

Complete restoration of the coating is necessary.

Abrade the damaged coating using a medium and then fine grade abrasive paper. Thoroughly clean the surface of dust, wash it, and then let the surface dry.

Treat bare wood with a surface preservative and let the preservative dry completely.

Prime with base coat stain in the original color in order to increase topcoat stain adhesion.

Using a long haired synthetic brush designed for use with acrylic paints, apply two layers of topcoat in the appropriate color and gloss level. Allow to dry for four hours before applying the second coat.

- **The natural swelling and contraction of wood lead to cracking of the coating or moisture penetrated joints and end grain**

Abrade the damaged coating using a medium and then fine grade abrasive paper. Thoroughly clean the surface of dust, wash it, and then let the surface dry.

Treat bare wood with a surface preservative and let the preservative dry completely.
Prime with base coat stain in the original color in order to increase topcoat stain adhesion.
Seal any open joints and end grains with joint sealer. Smooth out with a damp cloth or spatula and allow to dry.
Using a long haired synthetic brush designed for use with acrylic paints, apply two layers of topcoat in the appropriate color and gloss level. Allow to dry for four hours before applying the second coat.



Do not close sashes that can be opened and closed before the paint is completely dry.

Wooden parts are coated with eco friendly, water-based paint from TEKNOS. Therefore it is suggested for further protection of wooden parts to use water-based products.



It is not recommended to use pure acrylic paints for the final coats in rabbets as the seals have a tendency to stick to the surface. If acrylic paint is used, the part of the rabbet that is in contact with the seal must be rubbed with paraffin.

Do not paint over any seals or moving parts on hinges or closure fittings.

Do not paint over the guarantee mark.

Resin spots

Yellowish coloring from knots may occur especially with light shades of protective coating. Because wood is a living material, their appearance is a natural process and it does not indicate damage of the protective coating.

Resin stains may be significantly reduced by washing the areas around knots with a soft cloth soaked in 1:1 water and spirit solution and then rinsing the spot with clean water.

If the knots are particularly resinous, the resin may exude through the coating and form droplets on the surface. Refrain from removing the fresh resin exudate, as its moisture and stickiness indicate that the exudation process is still continuing. Leave the droplets of resin on the surface until they are dry and crystallized and then carefully remove them using a natural bristle brush, and wipe off residue (preferably while renovating the coatings).

3.3. Joints between the frame and wall

It is critical for the gap between the frame and the wall to be in good condition. They should be checked for defects at least once a year and in case there are any gaps found, they must be filled with the same type of filling material as used originally. If the gaps are very big, all existing material must be replaced to seal the gap properly.

3.4. Seals

All wood aluminium windows and doors are supplied with durable and weather resistant EPDM seals. Seals must not be painted over or have any wood protection applied. Certain types of emulsion paint can stick to the seals when dry, whereas alkyd emulsion paint and water based paints do not have such a problem. Most problems with sticking of enamel paint can also be eliminated by applying talcum or paraffin to both the seals and the affected surfaces. Should that not be possible, water based paints must be used.

Rubber gaskets should be treated with silicone lubricant at least twice a year. That will prevent the gasket from cracking during the winter time. This treatment will provide the necessary elasticity to ensure proper sealing of the window. Please ask for qualified person if the gaskets are damaged and need to be replaced.

3.5. Drainage holes

Check the weep holes and drainage channels. Free from dirt if necessary.

3.6. Fittings

Windows have been equiped with high quality fittings which means a high degree of operating comfort, proper functioning and a long service life. How often fittings should be maintained depends to a large extent on how they are used, how often they are operated, and not least on the environment the fittings are exposed to.

In order to ensure proper functioning of the fittings over the long term, the following maintenance work and/ or inspections should be carried out:

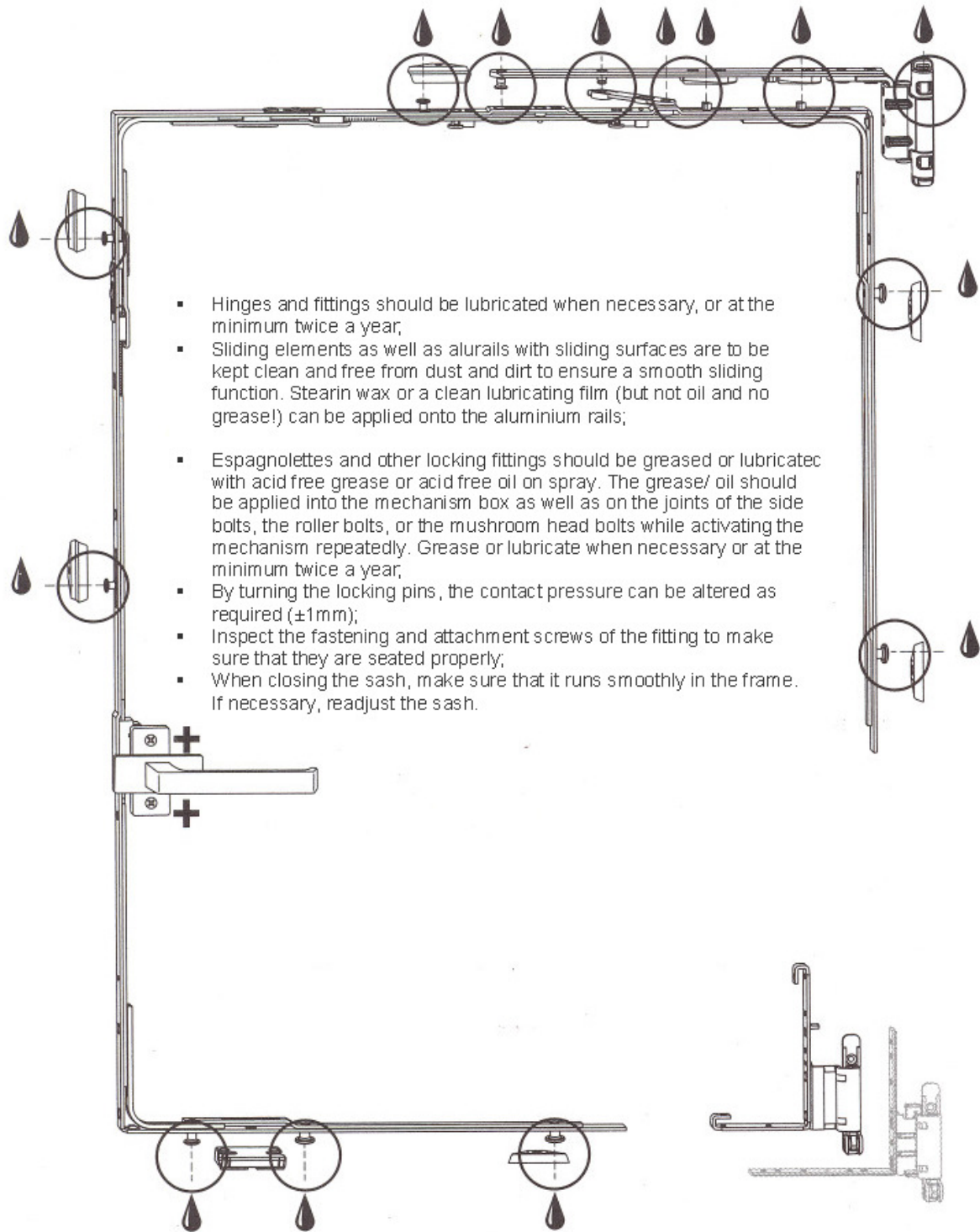

- Hinges and fittings should be lubricated when necessary, or at the minimum twice a year;
- Sliding elements as well as alurails with sliding surfaces are to be kept clean and free from dust and dirt to ensure a smooth sliding function. Stearin wax or a clean lubricating film (but not oil and no grease!) can be applied onto the aluminium rails;
- Espagnolettes and other locking fittings should be greased or lubricated with acid free grease or acid free oil on spray. The grease/ oil should be applied into the mechanism box as well as on the joints of the side bolts, the roller bolts, or the mushroom head bolts while activating the mechanism repeatedly. Grease or lubricate when necessary or at the minimum twice a year;
- By turning the locking pins, the contact pressure can be altered as required (± 1 mm);
- Inspect the fastening and attachment screws of the fitting to make sure that they are seated properly;
- When closing the sash, make sure that it runs smoothly in the frame. If necessary, readjust the sash.



Please use acid free oil to lubricate parts. WD40 is NOT suitable!

3.7. Lubrication points

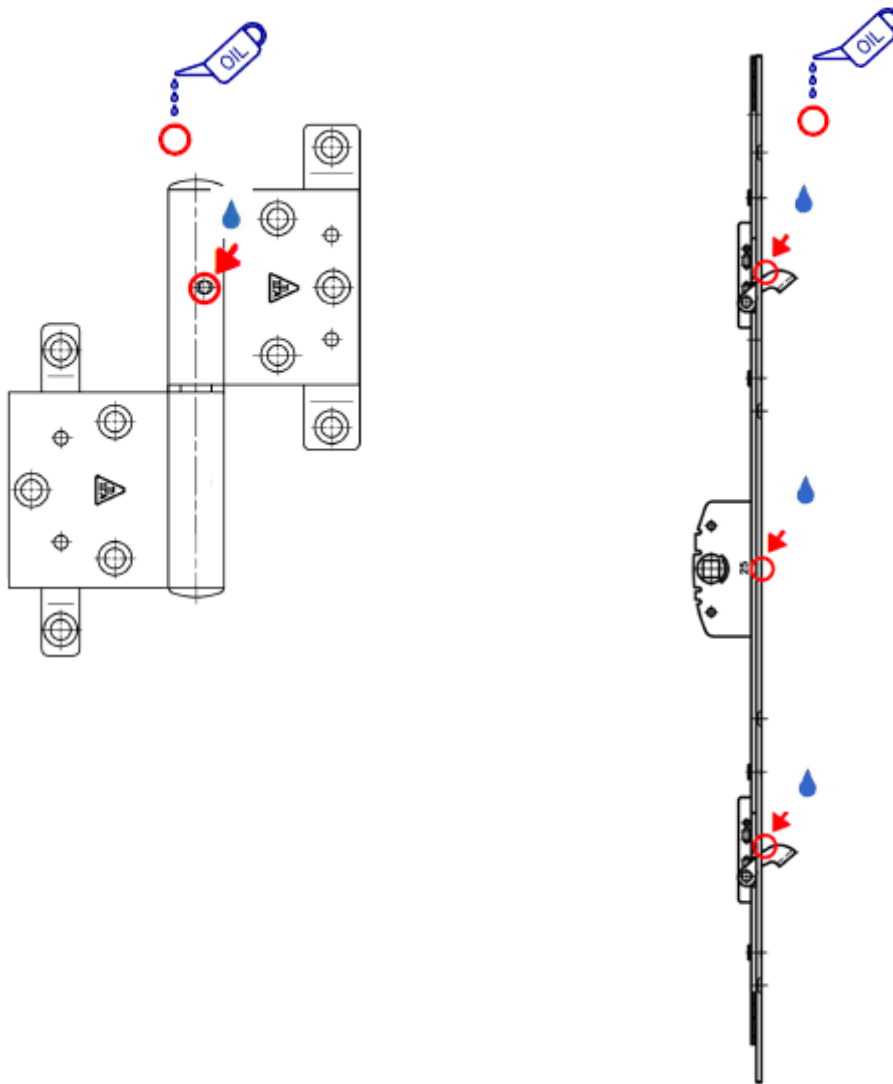

3.8. Inspection and maintenance of the glass

Before cleaning commences

Before proceeding with cleaning, determine whether the glass is clear, tinted or reflective. Surface damage can be more noticeable on reflective glass when compared with clear uncoated glass. If the reflective coated surface is exposed, either externally or internally, special care must be taken when cleansing as scratches can remove the coating and result in visible changes to the light transmittance. Specialist requires particular cleaning methods and the specific instructions for this product must be followed. Tinted and coated glasses should not be cleaned in direct sunlight, as the glass may be too hot for optimum cleaning. The cleaning solution will dry before effective cleaning has occurred and the dry surface may also promote scratching. Excessive temperature changes of the glass should also be avoided, for example splashing hot water on cold glass or cold water on hot glass.

It is strongly recommended that cleaning operators begin by cleaning a small area or window first then stop and examine the surface for any damage to the glass or coating bearing in mind that some types of scratches may be more visible under certain lightening conditions or times of the day.

Cleaning operations should commence at the top of the building and continue down to lower levels to reduce the risk of leaving residue and cleaning solution on glass.

Standard cleaning procedure

Cleaning during continuing construction work differs from ordinary routine cleaning mainly through the careful removal of debris from the glass surface. This is a delicate procedure and should be carried out by specifically trained professionals.



It is not recommended to wash glazed surfaces in winter time, when air temperature is below 0°C. If washing is a must, please add spirit to the washing liquid, which will decrease water freezing point in the washing liquid.

Water penetration and freezing behind glazing beads or on structures may cause glass breakage or other damages. Drying of glass will prevent unwanted consequences.

Cleaning should start by thoroughly soaking the glass with clean water and soap solution to loosen dirt or debris. Using mild, non-abrasive commercial window washing solution, uniformly apply the solution to the glass surfaces by spraying or with a brush, clean grit-free cloth or grit-free sponge. Using a circular motion and light to medium pressure, wipe the cleaning solution on the glass. Rinse the glass immediately with generous amounts of clean water making sure to remove all the cleaning solution. Use a clean lint-free cloth or a squeegee to dry the glass surface. Care should be taken to ensure that no metal parts of the cleaning equipment make contact with the glass surface and that no abrasive particles are trapped between the glass and cleaning materials.

All water and cleaning solution residue should be dried from window frames, seals and gaskets to avoid any potential deterioration of these materials. If residues are still present on the glass the steps above should be repeated. Abrasive cleaners, powder based cleaners, scouring pads or other harsh materials should be used to clean the glass or frame surrounds.

Excess glazing compounds and sealants should be carefully removed from the glass and frame surrounds, taking care not to scratch the finished surfaces with tools or abrasives. Avoid scraping the glass with metal scrapers or blades. A solvent such as white spirit or Professional glass cleaner may be used to remove any glazing compound, finger marks or grease taking care not to allow contact with glazing seals, gaskets, any paint finishes or the perimeter edge seal of an insulating glass unit. The glass can then be cleaned following the procedure above.

Glass with self-cleaning coating

Self-cleaning glass has a durable coating, and through utilisation of natural UV light, requires less frequent cleaning and provides clearer vision after rainfall.

Regular cleaning of self-cleaning glass should not normally be necessary. However, extended dry periods can cause a build-up of contaminants on the coated surface. Under such circumstances, hose down the window and let the glass dry naturally. Spraying should be conducted during the coolest part of the day, not in direct sunlight, from the top to the bottom in a zig zag pattern. Note! Pressure washers should not be used!

Periodically, the surface may become contaminated with stubborn marks that cannot easily be removed by hosing down the window. Where contamination occurs, the window should be hosed to remove any accumulation of dirt, cleaned with warm soapy water and a soft cloth, followed by a final water rinse. If necessary use a non-abrasive liquid glass cleaner, after the final water rinse. Do not trap dirt between the cloth and self-cleaning glass surface. Rubber squeegees should not be used as they may trap grit and damage the coated surface and the glass.

After cleaning with a soft cloth a period of reactivation may be required and typically this is 5-7 days.

Finger marks on the coated surface will, under normal circumstances, disappear. Where such marks persist, the glass should be cleaned as described above.

If silver-coloured areas or grease appear on the surface of the glass – this means that the coating is working and the oil-like stains will be washed away next time it rains.

Do not use abrasive cleaners, cream cleaners and functional (e.g. anti-mist) type products on self-cleaning glass, as they will damage the coated surface.

In areas of hard water supply, hosing down could result in white marks or milky appearance to the coated surface, caused by minerals in the water. Where this occurs, it is recommended that a solvent-free detergent be added via a suitable applicator to minimise the effect. The white marks can be minimised by avoiding hosing the glass at the hottest time of the day.



If the water quality is very hard (greater than 180ppm combined content of calcium carbonate CaCO_3 and magnesium carbonate MgCO_3), rinsing water should be softened with a domestic water softener or by adding a couple drops of detergent (such as dishwashing detergent) to a litre of water.

Do not splash paint or cement products on to the glass. If ink or paint gets onto the glass, remove it using a soft cloth and cleaner (methylated spirits). If cement gets onto the glass, remove it using a limescale remover. Never use scouring agents, steel wool, razor blades or other hard objects which scratch the glass.

Where self-cleaning glass are likely to be stained by white carbonate run-off from lead flashing (i.e. conservatory roofs), it is recommended that all lead adjacent to the glass surface is treated with patination oil prior to installation.



Please seek out specialist advice for removal of contaminating deposits!

Care should be taken to ensure that alkali run-off from concrete etc. does not contaminate the glass surface.

Under no circumstances should any metal objects or harsh chemical cleaners be used to clean or otherwise come into contact with the coated surface. Steel scrapers, razor blades, steel wool, squeegees, rings etc. will cause scratching and may lead to permanent damage of the coating.

All maintenance and repairs above and beyond basic cleaning needs should be carried out by recommended installer.



Silicone should never be used in conjunction with self-cleaning glass!

Glass staining

Water runoff flowing over the facade of a building may carry contaminants onto the surface of the glass. These contaminants cause stains on the glass and can be extremely difficult to remove sometimes even chemically bonding to the glass surface. The most effective way of addressing this problem is to prevent runoff reaching the glass at the design stage by use of suitable drainage techniques employing flashings, reveals or drips for example.

Lime scale and concrete stains can occur where rainwater has passed over masonry, concrete or mortar onto the glazing below. Insoluble salts of calcium crystallise on the glass surface and become chemically difficult to remove using Standard cleaning procedures.

Organic sealants may leach out solvents; oils or plasticizers and these may adhere very strongly onto the glass surface and cause staining. The sealant may not necessarily need to be adjacent to the glass to cause this problem as they could be carried over the glass by water runoff. This tends to be a greater problem when the building is new. Consult the sealant manufacturer for advice and follow their recommendations.

Watering metals release oxides as they age and can cause staining on adjacent glazing. They occur where rainwater passes over metal flashing or other architectural elements and deposits metal oxides onto glazing. Iron, zinc, lead and copper are particularly prone to cause problems of its nature. The oxides adhere tenaciously onto the glass and expensive chemical cleaning techniques may be required if they are left on the glass for any length of time. Glass should be examined frequently during construction to see if any build up is accruing. If so the glass should be cleaned immediately.

Weld spatter

This causes a rough and pitted surface on glass. Any glass that has been damaged by weld spatter should be replaced, as the strength of the glass will have been unpredictably reduced. Temporary screens should be installed if welding, sandblasting or other potentially damaging construction process is being carried out near the glass.

Quick reference guide

- Store glass in a safe manner in a suitable dry ventilated area out of direct sunlight and away from other sources of heat;
- Check the specification of the glass products concerned to determine if they are tinted, coated or reflective and follow any specific instructions from the supplier;
- Immediately remove any construction materials, i.e. concrete, fireproofing, paints, labels and tapes;
- Protect the glass surface from over spray or run-off from acids and cleaning agents used to clean metal framing, brick or masonry and splatter from welding processes;
- Keep all cleaning solutions and other materials from coming into contact with the edges of laminated glass or insulated glass;
- Avoid cleaning the glass in direct sunlight, particularly tinted or coated glasses;
- Clean frequently as and when dirt and residues appear on the glass both the external surface and the internal surface;
- Start cleaning at the top of the building and work downwards;
- Start by cleaning a small area first and assessing it to see if the cleaning procedures have caused any damage;
- Begin by thoroughly soaking the glass surface with clean water and soap solution to loosen debris and dirt;
- Don't use aggressive or abrasive cleaning solutions;
- Don't use aggressive cleaning materials - metal scrapers, razor blades or other objects that may scratch the glass;
- Glazing should never be cleaned with strongly alkaline washing solutions or with acids, particularly hydrofluoric acid or other cleaning agents containing fluoride. These solutions can destroy both the coating and the glass surface and thus lead to irreparable damage;
- Don't use petroleum products, i.e. petrol, diesel or lighter fluid;
- Make sure all cleaning solution is dried from gaskets, seals and frame surrounds;
- Regularly inspect and maintain the building and take remedial action as necessary or as recommended by the manufacturers.

3.9. Inspection and maintenance report

Regular (at least twice a year) inspection and maintenance of wood-aluminium structures following „Operation and Maintenance Manual for Wood Aluminium Glazed Structures” detailed above will help to preserve the original appearance and performance characteristics.

- Check condition of coating: any cracks, chipping and scaling of the surface should be repaired immediately by you or a qualified technician.
- Check for cracks in the filler for joints and connections. If such defects are detected, remove the filler completely and reapply.
- Make sure that bolts are in correct positions.
- Check the correct operation of hinges and handles. To ensure their smooth operation apply grease or oil after cleaning.
- Check adhesion of silicone to the glass.
- Wipe window seals with talcum powder once a year to prevent their sticking to coated surfaces.

Customer/ user has to make report (Annex 1) for each maintenance and send it on e-mail address info@ailegrupa.lv **Missing reports can lead to removal of warranty!**

4. VENTILATING YOUR HOMES

The recommended indoors humidity for wood-aluminium structures is 50 ... 60%, recommended temperature +18°C.

New windows will normally be airtight and there is therefore a greater requirement to be more systematic with airing of your home than with older, draughty windows.

If outside temperatures of 0° during the daylight and evening hours cause condensation to form on the inside of 2-layered double glazing in an ordinary sitting room, it is a sign that the air in the house is too humid.

Be therefore aware of the following:

- New windows are clearly more airtight than older windows. After a window change, there is therefore a greater need for airing than previously required.
- Newly built houses should be aired more than older houses.
- The drying out phase can often last for more than a year. That also applies to renovations and extensions.
- A grown person – or a medium large dog – emits approx. 2 litres of water every day.
- Moisture problems increase when room temperature falls and decrease when it rises. Even a drop in temperature of short duration during the night can cause condensation to form on the windowpanes.
- It is a balancing act to find the optimal point between saving energy and minimising moisture problems.
- Thick curtains and wide windowsills mean that the air can be stagnant at the windowpanes. The air then gets cold and moist and condensation forms on the glass.
- During days when the weather is calm, the sun will provide more free warmth than will disappear during normal airing.
- Insufficient airing results in a poor internal climate. It can result in coughs, headaches, sore eyes, skin problems and airway allergies.

5. ADVICE AND REPAIR

During maintenance and regulation works, access to the working place has to be provided only for the service specialists. Other people are denied access.

All the instruments to be used have to be provided. Maintenance staff that get around the glass surfaces and silicone joints must wear shoes with clean rubber soles.

During maintenance, have to pay attention to the laws of physics, which act between the design elements. Especially at places where glass, aluminium, silicone, etc. connect.

When surrounded by mud or other obstructive conditions, which cannot be completely eliminated even with the help of preventive measures, have to contact the supplier of the structures.

It is very important that the repair or rebuilding works are done by the same company that supplies the structures. Only in this case the production base guarantee remains.

Specialist firms should only get involved for specific things according to their specialization. This can especially be applied for furniture. As far as it is part of the guaranteed service, these works should be trusted to the company that has supplied and installed the products. This company would be the most competent because it would have an adequate problem solving plan, detailed plan for the respective project and the necessary parts in stock.

As a special service, could also offer a service and maintenance contract. Through this contract the client can be provided with all the necessary service and repair works. The service firm undertakes the maintenance of the structures with most careful attention to the materials and proper operation of all the functions, so that the client himself would not have to undertake prevention of any defects.

6. COMPLAINT GUIDELINES

6.1. Delivery of the products

Standard curtain sided trucks are not equipped with mechanism for unloading a cargo. Therefore the client has to unload it with their own equipment (e.g. forklift, crane). Should the client have no possibility to do so, they must inform the supplier well in advance in order to be able to find a solution.



It is not the duty of a driver to help in unloading a cargo.

Responsibility for windows and doors supplied by UPB is transferred to the customer immediately after the units have been unloaded from the truck.

- You must be present at the point of delivery because you are responsible for checking the units delivered for faults and defects, and for checking that the type and quantity of units delivered matches the type and quantity stated on the shipping note. If you cannot be present at the point of delivery, the items will be unloaded at your risk and will be considered to have been delivered free from faults and defects;
- If there are any indications of damage in transit, you must note this immediately on the shipping note. You must note this note fax/ mail latest within one week from reception of the goods. Damage in transit is said to exist if the packaging in which the units are packed is broken or damaged on arrival at the construction site;
- Other damage/ faults/ defects must be reported within one week from reception of the goods. Units with immediately visible damage/ faults/ defects must not be installed/ scrapped without the prior consent of the window manufacturer. If such items are installed/ scrapped, the customer's right to file complaints may be annulled;
- Take the picture of any damaged units while they are still on their transport pallets. These pictures should then be sent in along with the complaint.

6.2. Storage

Immediately after delivery the product must be appropriately protected against moisture (rain and snow), direct sunlight, soiling and other such undesirable influences. Storage areas should be well ventilated and not subject to extremes of temperature. Store the product off the ground on suitable, level bearers. Avoid unsuitable storage such as metal box containers and areas open to the elements. These may be subject to condensation and very high temperatures in direct sunlight. Water can also collect in the protective packaging leading to saturation of some components.

The top and sides of the pallet must also be covered with waterproof tarpaulins that are satisfactorily secured against windy conditions, and it must be possible for air to circulate under the pallet. The packaging applied at the factory is only intended to protect the units against dust and dirt between the factory and the construction site. Product damage attributable to incorrect storage is not covered by the product warranty.

6.3. Correct installation

Windows and doors must be installed in accordance with the instructions stated in fitting guidelines. The window fitter is responsible for correct installation. Damage attributable to incorrect installation is therefore not covered by product warranty.

6.4. Tolerances

Deviations from order dimensions give grounds for filing complaints with Aile Grupa if they exceeded the following tolerances:

- for exterior frame dimensions $\geq 2,0\text{m}$, the permitted tolerance is $\pm 3\text{mm}$ at 12% relative moisture in the wood;
- for exterior frame dimensions $< 2,0\text{m}$, the permitted tolerance is $\pm 2\text{mm}$ at 12% relative moisture in the wood;
- the permitted curvature in panel doors is 2mm per running metre.

Surface defects in aluminium (scratches, blisters, etc.) that are greater than 1,0 mm constitute grounds for complaint if they can be identified through visual inspection outdoors at a distance of 3 metres – although never in direct sunlight or backlight.

Aluminium colours may vary slightly, particularly in the case of anodised surfaces. In the event of doubt, the issue of whether the difference in colour gives grounds for complaint will be determined by Aile Grupa on inspection. On anodized surfaces, where the aluminium profiles have been processed after anodizing, minor stretching may appear. These stretching marks do not have any negative influence on the mechanical surface quality, and cannot be subject to claims covered by our product warranty.

Surface defects in wood

Wood is a natural product and star shakes, knots, resin leakage and grain/ gloss variations may occur.

Star shakes are a natural phenomenon in wood and may occur over time, these do not constitute grounds for complaint.

Knots are natural features of wood and cannot be avoided. However, the number of knots per side in an individual unit section must not exceed a whole number greater than $1+(10 \times L)$, where L equals the length of the unit measured in metres. In this context, a group of knots in which the distance between the individual knots is less than the width of the unit is considered a single knot. Plugs and other types of filling are also considered knots. Pin knots are not included in this definition.

Doors and windows that open inwards are more exposed to wind and weather conditions, so the proportion of core wood used in these units is higher. For this reason, there is a greater likelihood of their featuring knots and there are no limitations in practice on the permitted number.

Panel doors are covered with plywood. The plywood grain can be seen through the painted surface, so the door panel may appear rough compared to the door frame, which is made of solid wood. The surface is to be assessed at a distance of three metres and never in direct sunlight or backlight. Should the plywood loosen for no visible reason, a complaint about the door may be filed as long as the cause is attributable to manufacturing error or material defect.

Resin leakage occurs naturally in wood and therefore does not constitute grounds for complaint.

The surface treatment is to be assessed at a distance of three metres and never in direct sunlight or backlight.

Runs in the paintwork do give grounds for complaint and will be rectified by Aile Grupa as long as the complaint is filed within reasonable time from the date of delivery. Customers must generally accept that wood is a non-homogenous material. Plugged or sealant-filled knots will be visible. In addition, variations in colour may occur on account of the non-identical natural basic colour of the wood. Only in exceptional circumstances will such give grounds for complaint.

Difference in colour. In the event of doubt, the issue of whether differences in colour constitute ground for complaint will be determined by UPB on inspection.

Panes

Thermal stress damage, which typically takes the form of cracks perpendicular to the edges and through the thickness of the unit, does not give grounds for complaint.

Standard glass used in double glazing is considered clear, even though it is actually green or blue. Two pieces of glass of the same type but of different thicknesses may appear to feature *different shades*. It does not give grounds for complaint.

If faults or defects are observed, photograph the pane while the unit is still on the pallet and submit the photos together with a complaint within one week of delivery.

Moisture on the pane. External and internal moisture builds up naturally on panes and does not constitute grounds for complaint. However, the build-up of moisture between layers of glass indicates that the thermal window has been punctured.

6.5. Complaint

Please address complaints

- by post: SIA Aile Grupa, Pulvera iela 28, Liepāja, LV-3405 or
- on +371 63489301 or
- e-mail them to info@ailegrupa.lv

When contacting the company to file a complaint, please have the following information ready:

- the name, phone number and e-mail address of your contact, as well as the construction site address;
- position number, which is stated on the confirmation of order;
- a clear description of the complaint;
- supply photos whenever possible to show the problem.

In the event of doubt regarding whether a complaint is justified, the issue will be settled by UPB service technician on inspection. If the complaint is not justified, the complaining party will be invoiced for the time taken for the inspection.

7. WARRANTY

7.1. This guarantee is given by UPB. The warranty is valid if the installation and maintenance of the product is executed only by the experienced specialist or the company (the member of the appropriate window association) and the conditions of this instruction are fulfilled.

7.2. The Client may not claim defects in the product, unless he informs the UPB of the defects within the times and order stated hereinafter.

7.2.1. About visible faults, for which is responsible the UPB, shall be claimed immediately, but latest within week after completed delivery and before the Goods are assembled. The Buyer shall inform the Seller of it in writing together with photo. If there are visible defects at the time of receipt of Goods, the Buyer shall submit the claim in writing together with pictures of the defects. The photo must be taken before unloading the elements, but claim must be stated in the CMR/BL of the transport company of the cargo.

7.2.2. About the quality and hidden defect the Buyer shall inform immediately in writing together with photo, but latest within one week from the establishing the defect.

7.3. If notification is given according to point 7.2., the guarantee provides you with the rights in relation to UPB that are indicated in point 7.4. The date of manufacture appears as a mark on the product. If necessary, it is your responsibility to document the delivery time.

7.4. As long as there is documented notification of the visible, manufacturer's and/or material defect within the timeframe indicated in point 7.2., UPB is obliged to correct the defect or, if necessary, deliver a new product without remuneration. UPB does not cover costs associated with removal of the old (defected) product and installation of the new product. Similarly, no consequential work costs associated with changing the product will be covered by this guarantee.

7.5. If the product is no longer in production at the time of notification of defect, UPB is entitled to

deliver another instead, corresponding product, if needed. If the manufacturer's and/or material defect can be corrected in a responsible manner with a repair and/or partial change, UPB can choose this solution instead. The repair and/or partial change for this will be performed without remuneration.

7.6. This guarantee is not applicable if the established visible, manufacturer's and/or material defect are due to incorrect storage, handling, mounting, poor or insufficient maintenance or incorrect use.

7.7. In as far as it concerns the window's wooden components that are treated by the manufacturer; attention is drawn especially to the „Operation and Maintenance Manual for Wood Aluminium Structures” and „Expected performance of industrial surface treatment of timber elements” (Annex 14, Technical requirements of Association of the Danish Window Manufacturers). The requirements can be requested from UPB. It is important that the window's external surfaces are maintained by cleaning twice a year in order to ensure that the surface treatment maintains its durability. If you have not received „Operation and maintenance instructions for wood aluminium structures” with your delivery, they must be requested directly from UPB.

7.8. The delivery of new product instead of defected product or the correction, rectification works of defected product shall be performed at the product delivery address, which was agreed within the confirmed price offer and/or separate supply agreement, if parties do not agree otherwise in writing.

7.9. UPB guarantees for a period of 3 years calculated from the date of manufacture stamped on the door, that the multiple glazed window panes mounted in doors and/or windows will remain free of dust and condensation on the pane's internal surfaces.

7.10. The guarantee is determined by whether:

- The pane in the sash is supplied with a production time (month and year).
- The pane is correctly cleaned and protected during the construction period.
- The pane is not damaged by other items, for example a shock, blow, movement in adjacent construction etc.
- There is no damage resulting from frost, overall thermal effects or chemical attacks on the glass.
- The pane has not been further modified after delivery, for example by sanding, sand blasting, etching, painting, gluing or any other surface treatment.
- The necessary, ongoing maintenance of the sash/frame has been performed.
- This guarantee is valid if general installation rules have been observed.
- This guarantee is valid, if construction/s is/are leveled properly while installed and the structures are not deformed.

7.11. The guarantee for insulating glass units which have “attached” and/or “built in” elements, such as lead light, alarm systems, venetian blinds etc. will be applied and ensured insofar as UPB receives from the appropriate producer of those items. If the appropriate item producer during the guarantee period becomes insolvent or bankrupt, the UPB does not take their obligation and is not responsible for the mechanical etc. defects

7.12. In case of establishing a damage or defect of insulating glass unit, photo evidence should be made and the UPB should be informed in writing about the case. In case of a claim for a cracked glass it is a obligation and precondition for accepting the claim to attach 3 pictures of damaged glass to the claim from the following views:

1. picture – before the glass is taken out of the structure;
2. picture – from the place where the crack starts, if necessary taking off the covers, cover profiles, glazing beads etc.
3. picture – side view of insulating glass unit after it is taken out of structure, with the damaged place.

7.13. There is a 1-year guarantee for all electrical accessories.

8. DVC - DANSK VINDUES CERTIFICERING

Aile COto windows and doors conform to DVC (Dansk Vindues Certificering) quality claims and they have the DVC mark. DVC is an entirely independent control organisation connected to the Danish Technological institute. Certification by DVC means that the systematic inspection of the products and quality control of the company is performed at least once every year.

The DVC system imposes requirements on the manufacturer's management and quality control, the construction of the product, the quality of the material, the craftsmanship etc.



SIA „Aile Grupa”
Glazed structures, windows, doors, facades

Pulvera 28, Liepāja
Latvia, LV- 3405

Phone.: (+371) 63489300
Fax: (+371) 63489301

Maskavas 250, Rīga
Latvia, LV - 1063

Phone: (+371) 67813800
Fax: (+371) 67813801

info@ailegrupa.lv
www.ailegrupa.lv
www.upb.lv

Maintenance REPORT for Wood Aluminium Structures

Annex 1

Customer			Project name				
Contract No.			Project address				
	PROFILES	GLASS SURFACES	JOINTS		GASKETS	FITIINGS			
	Cleaning with fabric cloth	Wet cleaning	Inspecting the joints for cracks	Cleaning the joints (pH neutral)	Cleaning and inspecting for cracks	Adjusting and inspecting for cracks	Lubricating the fittings	Inspecting for smooth movement without obstructions	
	Yes <input type="checkbox"/> No <input type="checkbox"/>	Yes <input type="checkbox"/> No <input type="checkbox"/>	Yes <input type="checkbox"/> No <input type="checkbox"/>	Yes <input type="checkbox"/> No <input type="checkbox"/>	Yes <input type="checkbox"/> No <input type="checkbox"/>	Yes <input type="checkbox"/> No <input type="checkbox"/>	Yes <input type="checkbox"/> No <input type="checkbox"/>	Yes <input type="checkbox"/> No <input type="checkbox"/>	
Maintenance completed, comments	
Defect observed, comments should be made compulsory	Yes <input type="checkbox"/> No <input type="checkbox"/>	Yes <input type="checkbox"/> No <input type="checkbox"/>	Yes <input type="checkbox"/> No <input type="checkbox"/>	Yes <input type="checkbox"/> No <input type="checkbox"/>	Yes <input type="checkbox"/> No <input type="checkbox"/>	Yes <input type="checkbox"/> No <input type="checkbox"/>	Yes <input type="checkbox"/> No <input type="checkbox"/>	Yes <input type="checkbox"/> No <input type="checkbox"/>	
	

Maintenance performed by: _____

Date: _____

signature

Regular maintenance of wood aluminium structures twice a year is required! Maintenance report has to be sent to e-mail: info@aillegrupa.lv